

Paine™ 210-30-110 Series Pressure Transducer

mV/V, Low Level, +121 °C, Ranges to 5,000 PSIS (244 BAR)

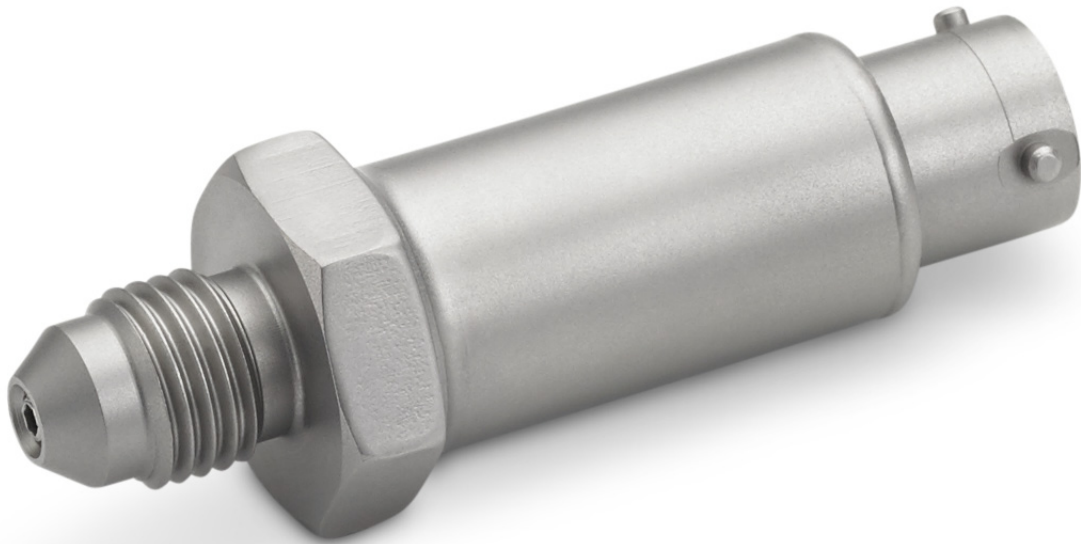

The Paine 210-30-110 Series is a sealed, rugged, all-welded stainless steel transducer used in general low level applications. Designed to operate in rigorous hydraulic and pneumatic systems, the Paine 210-30-110 Series provides highly accurate and reliable system pressure monitoring directly at the point of measurement. Available in many pressure ranges (18 options available) with optional voltage inputs, electrical connections, pressure ports, special testing, and thermal compensation.

Solution

- PSIS and PSIA (sealed and absolute options)
- All-welded, sealed construction
- Harsh/extreme environment ready

Potential applications

- Flight and brake controls
- Guidance systems
- Industrial and petroleum processing
- Military ground vehicle hydraulic monitoring
- Liquid and solid propellant combustion chamber pressure
- Liquid level of depth

Features

- **Full Scale (F.S.) sensitivity:** 3.0 mV/V \pm 10%
- **Output at zero pressure:** 0 \pm 5% of F.S.
- **Operating temperature:** 65 to +250 °F (-53 to +121 °C)
- **Pressure range:** 0–500 to 0–2,000 psis (34 to 137 bar)
- **Operating media:** Any compatible with 15-5 PH CRES condition H1025 and 304 CRES
- **Pressure fitting:** Boss mounting per MS33649-4 using MS28775-012 size O-ring

Specifications

Calibration: Calibration certificates are supplied with each unit and available online.

Performance

Full Scale (F.S.) sensitivity: 3.0 mV/V \pm 10%

Thermal zero shift: \pm 0.01% of F.S. per °F maximum

Thermal sensitivity shift: \pm 0.01% of F.S. per °F maximum

Static error band (non-linearity, hysteresis): See “Pressure Table” on page 3.

Output at zero pressure: 0 \pm 5% of F.S.

Repeatability: Within \pm 0.05% of F.S.

Environmental

Environmental: Error due to combined effect of shock, vibration, and acceleration shall be less than 0.01% of F.S. per G.

- **Acceleration:** 20 G's per MIL-STD-810, method 513.1, Procedure I
- **Vibration:** 20 G's per MIL-STD-810, method 514.1, Procedure V Part 1
- **Shock:** 30 G's Per Mil-STD-810, Method 516.1, Procedure IV

Operating temperature range: –65 to +250 °F (-53 to +121 °C)

Compensated temperature range: –25 to +250 °F (+31 to +121 °C)

Contents

Specifications 2 Dimensional Drawings 4

Mechanical

Pressure range: Contact factory for additional pressure ranges. PSIA (absolute) pressure ranges are also available.

Table 1. Pressure Table

| Standard part number | Pressure range PSIS ⁽¹⁾ (BAR) | Proof pressure PSIS (BAR) | Burst pressure PSIA (BAR) | Static error band (BSLM) |
|----------------------|--|---------------------------|---------------------------|--------------------------|
| 210-30-110-01 | 0–500 (0–34) | 750 (51) | 1,250 (86) | ±0.35% F.S. |
| 210-30-110-02 | 0–1,000 (0–68) | 1,500 (103) | 2,500 (172) | ±0.35% F.S. |
| 210-30-110-04 | 0–2,000 (0–137) | 3,000 (206) | 5,000 (344) | ±0.35% F.S. |

1. PSIS designation references a sealed chamber. The output is referenced to 14,696 PSIA.

Operating media: Any compatible with 15-5 PH CRES condition H1025 and 304 CRES

Pressure fitting: Boss mounting per MS33649-4 using MS28775-012 size O-ring

Recommended installation torque: 65 in-lb maximum

Optional mounting: 0.250 outside diameter (O.D.) tubing with 37° flare

Electrical

Excitation: 10 VDC

Input resistance: 350 ± 70 Ω

Output resistance: 350 ± 35 Ω

Electrical connections: Four pin bayonet locking electrical connector. Mates with MS3116-8-4S. (P/N: 247-99-100-01 sold separately).

Dimensional Drawings

Figure 1. Paine 210-30-110 Series

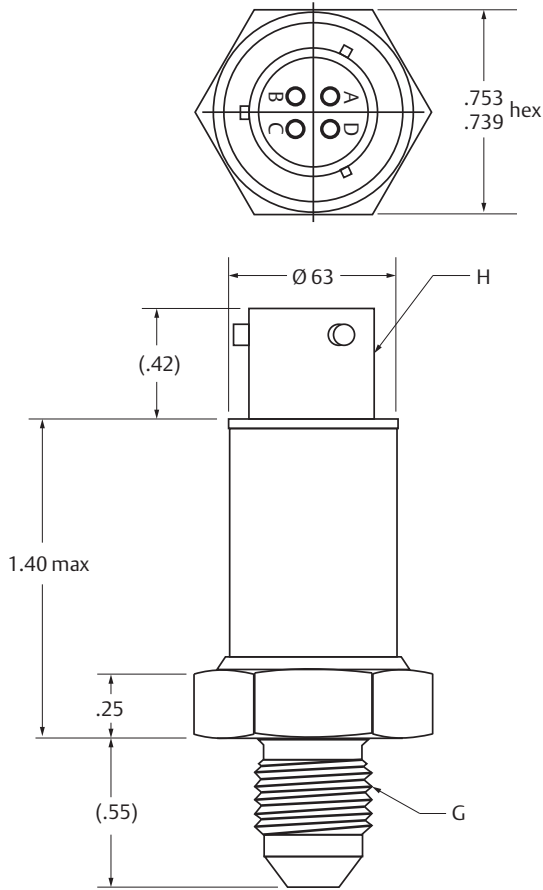

| Connections | |
|-------------|--------------|
| PIN | Function |
| A | + Excitation |
| B | + Signal |
| C | - Signal |
| D | - Excitation |



A - D. See Connections table
 G. Pressure fitting per MS33656-E4 except I.D.
 H. Four pin bayonet lock electrical connector
 Dimensions are shown in inches.

This page is intentionally left blank.

Rosemount Specialty Product LLC

Emerson Automation Solutions

5545 Nelpar Drive
East Wenatchee, WA 98822, USA

-  +1 509 881 2100
-  +1 509 881 2115
-  Paine.Products@Emerson.com

 [Linkedin.com/company/Emerson-Automation-Solutions](https://www.linkedin.com/company/Emerson-Automation-Solutions)

 [Twitter.com/Rosemount_News](https://twitter.com/Rosemount_News)

 [Facebook.com/Rosemount](https://www.facebook.com/Rosemount)

 [Youtube.com/user/RosemountMeasurement](https://www.youtube.com/user/RosemountMeasurement)

 [Google.com/+RosemountMeasurement](https://www.google.com/+RosemountMeasurement)

Standard Terms and Conditions of Sale can be found on the [Terms and Conditions of Sale page](#).
The Emerson logo is a trademark and service mark of Emerson Electric Co.
The Paine brand and Paine logotype are trademarks of Emerson Electric Co.
All other marks are the property of their respective owners.
© 2017 Emerson. All rights reserved.